



GigaSpire BLAST u6/u12 Installation Guide

November 2021

#220-01209-11



Contents

About this Guide.....	5
Chapter 1 GS202xE/GS422xE/GS4227 GigaSpire Overview ..	7
Agency Listing.....	10
Site Preparation	13
Before you Begin.....	14
Introduction.....	14
Chapter 2 Installation.....	15
Installation Tips	15
Installation Variables.....	16
Unpacking the GigaSpire	17
Tabletop Mounting Dimensions	18
Wall Mounting Dimensions.....	19
Tabletop Mounting the GigaSpire BLAST	19
Wall Mounting the GigaSpire BLAST	20
Additional Mounting Considerations	22

Chapter 3 Final Set-up and Testing	25
BLAST Reset Behavior.....	25
Powering the GigaSpire BLAST - No UPS	27
(Optional) Mounting the UPS	27
Connecting to the Internet	29
LED States - GigaSpire Turn-up	31
LED States - WPS Functionality	32
LED States - Miscellaneous Controls.....	34
LED States - Alexa	35
LED States - u6.1, u6.2, u6x	36
GigaMesh LED Behavior	37

About this Guide

This document provides general installation practices for the Calix GigaSpire BLAST u12 (GS202xE) and u6 (GS422xE).

This document also provides a general description of the products, and guidance for planning, site preparation, power installation, splicing to the outside plant, and basic troubleshooting.

Intended Audiences

This document is intended for use by network planning engineers, outside plant engineers, field support personnel, and craft personnel responsible for installation and maintenance of Calix premises equipment.

Federal Communications Commission (FCC) Statement

This equipment has been tested and found to comply with the limits for a Class B digital device, pursuant to Part 15 of the FCC rules. These limits are designed to provide reasonable protection against harmful interference when the equipment is operated in a commercial environment. This equipment generates, uses, and can radiate radio frequency energy, and, if not installed and used in accordance with the instruction manual, may cause interference to radio communications. Operation of this equipment in a residential area may cause harmful interference; the user will be required to correct the interference at his expense.

Safety Notices

This document uses the following safety notice conventions.



DANGER! Danger indicates the presence of a hazard that will cause severe personal injury or death if not avoided.



WARNING! Warning indicates the presence of a hazard that can cause severe personal injury if not avoided.



CAUTION! Caution indicates the presence of a hazard that can cause minor to moderate personal injury if not avoided.



ALERT! Alert indicates the presence of a hazard that can cause damage to equipment or software, loss of data, or service interruption if not avoided.



DANGER! CLASS 1 LASER PRODUCT. INVISIBLE LASER RADIATION MAY BE PRESENT. Fiber optic radiation can cause severe eye damage or blindness. Do not look into the open end of an optical fiber.

IMPORTANT SAFETY INSTRUCTIONS

When using your equipment, basic safety precautions must always be followed to reduce the risk of fire, electric shock, and injury to persons, including the following:

- Do not use this product near water. For example, near a bathtub, washbowl, kitchen sink, or laundry tub, in a wet basement, or near a swimming pool.
- Use only the power cord indicated in this manual.
- For external power supplies, the external power supply used in this device is to be Class II or a Limited Power Source (LPS) power supply.



Chapter 1

GS202xE/GS422xE/GS4227 GigaSpire Overview

The Calix GigaSpire family is the next generation residential premises service delivery platform that extends the access network into the home and acts as a strategic location for control of the voice recognition experience. Besides supporting broadband connectivity of data and video services, this intelligent, high-performance multi-Gigabit service platform is the industry's only premises-based wireless access point (WAP) that offers the latest 802.11ax Wi-Fi technology, and extends voice recognition capabilities. The GS2020E and GS2026E provides switching and routing functions that support speeds up to Gigabit symmetrically WAN throughput with two LAN and WAN Gigabit Ethernet (GE) ports for IPTV video and data services.

With the release of EXOS R21.2, the GigaSpire BLAST GS4227 is now available. This BLAST u6x is a new generation smart home system that integrates optical network termination (ONT) and residential gateway functionality into a single system. It supports any passive optical network and Ethernet technology while providing the ultimate Wi-Fi experience. In addition to supporting broadband connectivity of data and video services, the system offers the latest 802.11ax "Wi-Fi 6" technology. The u6x provides switching and routing functions that support multi-Gigabit throughput for IPTV video and data services. The BLAST u6x incorporates a WAN interface using a pluggable SFP+ module securely located behind a removeable panel next to the external interface assembly.

Name	GigaSpire BLAST ^{u12x}	GigaSpire BLAST ^{u12}	GigaSpire BLAST ^{u6.2}	GigaSpire BLAST ^{u6.1}
Product Name	GS2026E	GS2020E	GS4227E	GS4220E
Ethernet WAN (10/100/1000)	1	1	No	1
Ethernet WAN (10/1000/2500)	No	No	1	No
LAN	GE 1	GE 1	GE 1-4	GE 1-4
Wi-Fi - 2.4 GHz	4x4 802.11ax	4x4 802.11ax	2x2 802.11ax	2x2 802.11ax
Wi-Fi - 5 GHz	8x8 802.11ax	8x8 802.11ax	4x4 802.11ax	4x4 802.11ax
Wi-Fi Protocol	Wi-Fi 6	Wi-Fi 6	Wi-Fi 6	Wi-Fi 6
Voice Recognition	Yes	No	No	No
Bluetooth	BT/BLE	N/A	BT/BLE	N/A
Security	PuF	PuF	PuF	PuF
LTEN/A	m2	m2	m2	m2
Housing	4.75" L x 4.75" W x 8.5" H	4.75" L x 4.75" W x 8.5" H	4.75" L x 4.75" W x 8.5" H	4.75" L x 4.75" W x 8.5" H

The GS2026E GigaSpire BLAST^{u12x} and GS4227E GigaSpire BLAST^{u6.2} are the industry's only voice recognition wireless access point (WAP) that delivers the latest Wi-Fi technology (802.11ax) and voice recognition on a single platform. The GigaSpire service delivery platform uses a Gigabit Ethernet link at the subscriber's premises to provide carrier-class Wi-Fi and Gigabit Ethernet interfaces for customer multi-media devices. The GigaSpire enables residential subscribers to receive Gigabit broadband data, Internet Protocol (IP) video, and Voice over IP (VoIP) services. These GigaSpire use the latest 802.11ax 2.4 and 5 GHz technology incorporating 12x12 streams (4x4 2.4 GHz and 8x8 5 GHz) of Wi-Fi delivery on the model BLAST^{u12} and BLAST^{u12x}, while the BLAST^{u6.1/u6.2} provide 2x2 (2.4 GHz) and 4x4 (5 GHz) streams. In addition, with multi-user multiple-input and multiple-output (MU-MIMO) and beamforming, the GS2026E/GS4227E GigaSpire allows service providers to extend the access network inside the home and establish a strategic location for the delivery and control of broadband services. A USB port is available for connectivity and data storage applications.

With Wi-Fi being the de facto wireless data communication technology of choice for consumers, Calix engineered the GS2026E GigaSpire BLAST^{u12x} and GS4227E GigaSpire BLAST^{u6.2} for optimal whole-home coverage with simultaneous dual-band 2.4 GHz and 5 GHz operation and dynamic beam-forming at 5 GHz. Leveraging the latest 802.11ax features, these GigaSpire provides longer range, higher efficiency and less interference compared to earlier generations of Wi-Fi technology. For maximum performance, the GS2026E/GS2020E supports high-power 8x8 MIMO spatial diversity MU-MIMO at 5 GHz. They also supports the entire 5 GHz band and can be provisioned to support 160 MHz channel bandwidth at 5 GHz. The GigaSpire BLAST^{u12x} solution easily delivers high definition (HD) and ultra-HD (UHD) video and data throughout a subscriber's home in an increasingly video-rich and mobile broadband environment.

Each GigaSpire product can have a dual personality. It can either be a Gateway or a Mesh point depending on the software being implemented. For example, if the GS2026E is loaded with the Gateway EXOS software, it will be a Gateway. At the same time, if one desires to have the GM2020E GigaSpire BLAST as satellite mesh points, the mesh EXOS software is to be installed. With Gateway and Mesh units, they form a mesh network.

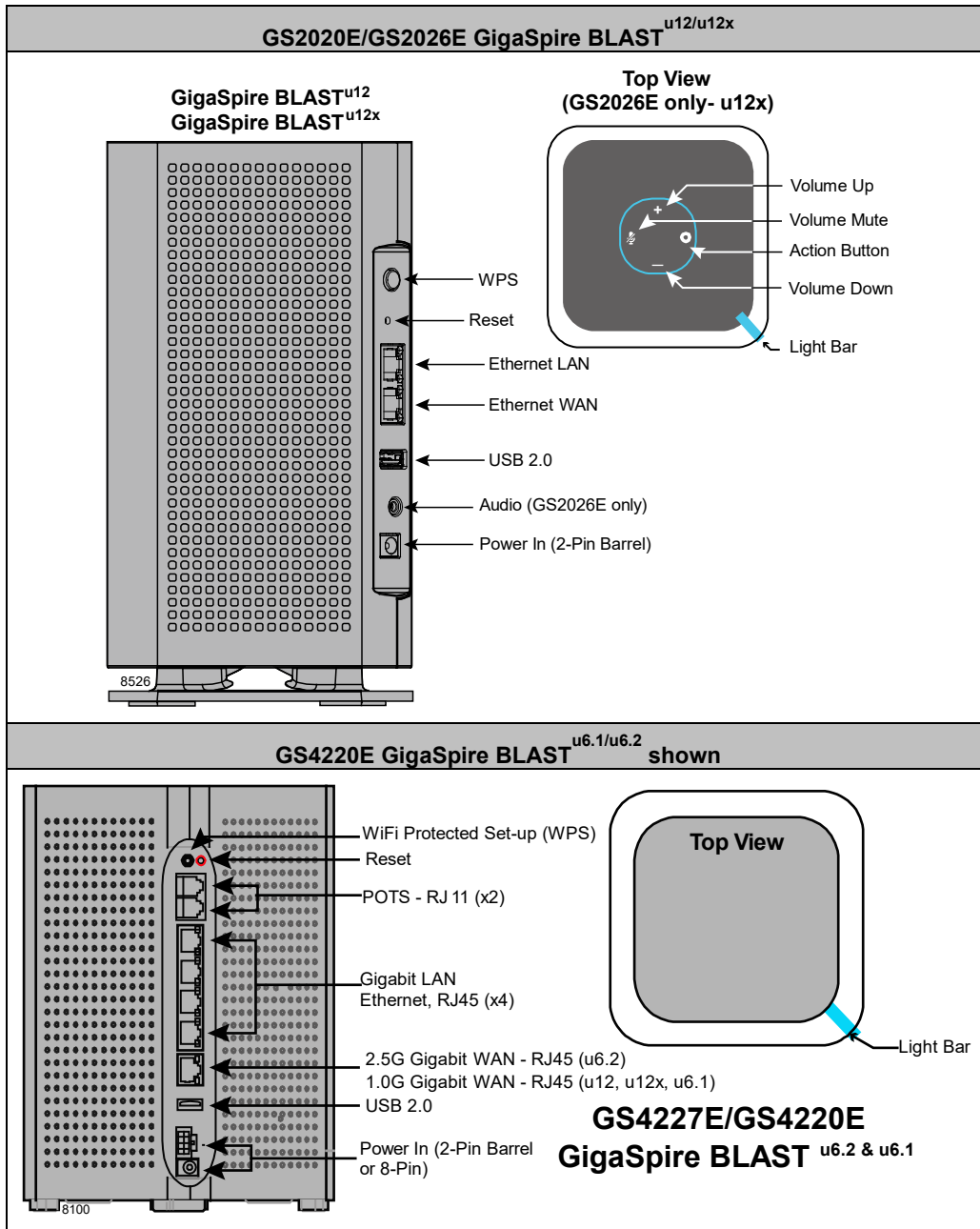

Agency Listing

FCC WARNING: These devices comply with Part 15 of the FCC Rules and Regulations. Operation is subject to the following conditions.

This device may not cause harmful interference, and, this device must withstand any interference received, including interference that may cause undesired operation.

The ONT has been tested and found to comply with the limits for a Class B digital device pursuant to Part 15 of the FCC Rules and Regulations. These limits are designed to provide reasonable protection against harmful interference when this equipment is operated in a commercial environment. This equipment generates, uses, and can radiate radio frequency energy and, if not installed and used in accordance with the instructions in this guide, may cause harmful interference to radio and television communications. Operation of this equipment in a residential area may cause harmful interference. The user will be required to correct the interference at their expense.

Note: This equipment has been tested and found to comply with the limits for a Class B digital device, pursuant to part 15 of the FCC Rules. These limits are designed to provide reasonable protection against harmful interference in a residential installation. This equipment generates, uses and can radiate radio frequency energy and, if not installed and used in accordance with the instructions, may cause harmful interference to radio communications. However, there is no guarantee that interference will not occur in a particular installation. If this equipment does cause harmful interference to radio or television reception, which can be determined by turning the equipment off and on, the user is encouraged to try to correct the interference by one or more of the following measures:

- Reorient or relocate the receiving antenna.
- Increase the separation between the equipment and receiver.
- Connect the equipment into an outlet on a circuit different from that to which the receiver is connected.
- Consult the dealer or an experienced radio/TV technician for help.

Any changes or modifications not expressly approved by the party responsible for compliance could void the user's authority to operate this equipment.

Hazardous Materials

There are no hazardous materials identified for the GigaSpire.

Application Standards

Following is a list of standards that apply to this product:

GigaSpire BLAST Standards		
FCC Part 15, Sub Part B, class B	UL 60950-1	EN 300 328
CAN ICES-003 Class B	CSA C22.2 No. 60950-1	EN 301 893
ANSI C63.4	IEC 60950-1	EN 301 489-1
FCC Part 2.1091	IEC 60825-1 / CDRH Class 1 Laser	EN 301 489-17
FCC Part 15.247	ITU-T K21	EN 55032 Class B
FCC Part 15.203	ITU-T K44	EN 61000-3-2
FCC Part 15.207	EN 60950-1	EN 61000-3-3
FCC Part 15.209	EN 60825-1	EN 50581
RSS 102	EN 62311	EN 50564
RSS 247	CE / RED, RoHS, WEEE, Energy	CISPR 32 Class B
FCC Part 15.407	RCM	IEEE: 802.3, 802.3AB, 302.3U, 802.11p, 802.11Q
NEC(National Electrical Code)	UL/ITC 62386	

Radiated Emissions

- This Class-B digital device complies with radiated emissions requirements as defined in Canadian ICES-003.

Émissions par rayonnement

- Cet appareil numérique de classe B est conforme aux exigences en matière d'émissions par rayonnement telles que définies dans la norme canadienne NMB-003.

Power Cables

- The unit must be powered by an external power source as follows: CE marked (EU), FCC (US), UL listed power source marked Class II, Limited Power Source (LPS) and rated output between 10-15 VDC (12 VDC nominal), 1 Amp minimum.

Power Cable Specifications		
Model	Power Supply Type	Output (Nominal)
u6.1, u6.2	AC to 12 VDC Power Adapter	3.0 Amp
u12, u12x	2-pin Power Cable	5.0 Amp

Câbles d'alimentation

- L'appareil doit être alimenté par un bloc d'alimentation externe comme suit : source d'énergie avec marquage CE (UE), FCC (États-Unis), homologuée UL, marquage de classe II, source d'énergie limitée (LPS) et d'une puissance nominale comprise entre 10 et 15 V CC (puissance nominale de 12 V CC) et de 1 A minimum.

Spécifications du câble d'alimentation		
Modèle	Type d'alimentation	Puissance Nominale
u6.1, u6.2	Bloc d'alimentation c.a.	3.0 A
u12, u12x	Bloc d'alimentation à 2 broches	5.0 A

Laser Standards

- Complies with 21 CFR 1040.10 and 1040.11 except for conformance with IEC 60825-1 Ed. 3., as described in Laser Notice No. 56, dated May 8, 2019
- CLASS 1 LASER PRODUCT & COMPLIES WITH IEC 60825-1:2014

Normes laser

- Conforme aux normes 21 CFR 1040.10 et 1040.11 à l'exception de la norme CEI 60825-1 3e éd., comme décrit dans l'avis laser n° 56, daté du 8 mai 2019
- PRODUIT LASER DE CLASSE 1 ET CONFORME À LA NORME CEI 60825-1:2014

Power Supply

This product is intended to be supplied by a Listed Power Adapter or DC power source marked "L.P.S." (or "Limited Power Source"), rated 12 VDC, 3.0 A minimum, T_{ma} = 40° C minimum; min 3048m.

Note: When using the standard power adapter, units will be inoperable after loss of main power.

Alimentation

Ce produit est destiné à être alimenté par un adaptateur d'alimentation homologué ou une source d'énergie CC marqués <L.P.S> (ou <Source d'énergie limitée>) d'une puissance nominale de 12 VDC, de 3 A minimum, ATM = 40 °C; altitude minimale de 3,048 m.

Pour réduire les éventuels problèmes de sécurité, seul l'adaptateur d'alimentation ou la batterie de secours fourni avec le produit, un adaptateur d'alimentation de remplacement ou une batterie de secours fourni par Calix ou ses revendeurs, ou un adaptateur d'alimentation ou une batterie de secours acheté comme accessoire auprès de Calix ou de ses revendeurs doit être utilisé avec le produit.

Remarque : Lors de l'utilisation de l'adaptateur d'alimentation standard, les équipements seront inutilisables après la perte d'alimentation principale.

An external power supply is included with the following rating:

GigaSpire BLAST^{u12}/BLAST^{u12X}

- Input voltage: 12 VDC (nominal)
- 10 VDC (min.), 15 VDC (max)
- External Power Adapter: 12 VDC, 4.5 - 5A

Un bloc d'alimentation externe, dont la puissance est mentionnée ci-dessous, est inclus :

GigaSpire BLAST^{u12}/BLAST^{u12X}

- Tension d'entrée : 12 V CC (nominale)
- 10 V CC (min.), 15 V CC (max)

Adaptateur d'alimentation externe : 12 V CC, 4,5 à 5 A

GigaSpire BLAST^{u6.1}/BLAST^{u6.2}

- Input voltage: 12 VDC (nominal)
- 10 VDC (min.), 15 VDC (max)
- External Power Adapter: 12 VDC, 3A

GigaSpire BLASTu6.1/BLASTu6.2

- Tension d'entrée : 12 VCC (nominale)
- 10 VCC (min.), 15 VCC (max)

Adaptateur d'alimentation externe : 12 V CC, 3A



DANGER! Using non-approved or incorrect power adapters can result in injury.

Site Preparation

Before you install any GigaSpire, you need to consider the routing of the power adapter cord and Ethernet cable (if used). **Note:** It is critical that you maintain the proper airflow in and around the unit. GigaSpire devices are designed for surface mounting only. Do not install cabinetry or other building material around the outside of the unit.

Power Cords

In order to complete the installation, a power cord in one of two configurations is required:

- GigaSpire Connectorized Power and Signal Cable - A 2-pin barrel connector to the local AC power receptacle (Type A).
- GigaSpire 8-pin connectorized power and signal cable - for use with the optional Universal Power Supply (UPS).

Before you Begin

Before starting the installation process, check that the following conditions are met:

- Ensure the site preparation steps are complete based on the model being installed.
- Ensure that all components are on-site and readily available to complete the installation.
- The customer is aware of your planned visit and will provide access to the inside of the home.

Introduction

This document describes the installation of the following:

- GigaSpire BLAST u6.2
- GigaSpire BLAST u6.1
- GigaSpire BLAST u6.x
- GigaSpire BLAST u12
- GigaSpire BLAST u12x

All BLAST units above are designed to be placed in a horizontal table-top configuration or can be wall mounted using the optional wall mount bracket.

Powering Options

- By attaching to any 110/220 VAC power outlet using the supplied 12 VDC wall transformer.
- For the BLAST u6.1, u6.2, and u6.x a UPS may be used. In this configuration, UPS with alarm telemetry and an 8-pin connector on the GigaSpire attaches to an 8-pin connector on the UPS.

Note: For all models, the power cord configuration must be appropriate for use in the country where the device is being deployed.

Note: Only Calix provided and approved power cords or voltage adapters should be used to connect to this product(s).

Chapter 2

Installation

Installation Tips



CAUTION! Use of controls or adjustments or performance of procedures other than those specified here may result in hazardous radiation exposure.

Follow these tips when installing a GigaSpire device.

- For subscribers using data services, all data wiring inside the home must be CAT5 cable or better.
- Make sure subscriber connections are tightened properly.
- Check the contents of each box carefully as you receive them. Components may not be located where you might expect them due to certain items being tested immediately before shipment.

About Wi-Fi Placement

Certain building materials are particularly effective at blocking Wi-Fi signals (see table below) and should be considered when locating the GigaSpire. Line of sight is not necessary since MIMO technology takes advantage of reflections in the over-the-air path to carry additional data. However, Calix recommends that when possible, Calix GigaSpire should be placed in a centralized location within the home to yield the best possible results for Wi-Fi coverage.

Building Materials and Their Effect on Wi-Fi Signals	
Material	Wi-Fi Attenuation
Wood, Drywall, Particle Board, Tile	Low
Glass	Low
Water	Medium
Bricks, Cinder Block	Medium
Plaster, Stucco	High
Concrete	High
Tinted or Low-E Glass (metalized)	Very High
Metal	Very High
Note: The lower the attenuation, the better the performance.	

Installation Variables

Before installing the GigaSpire, consider what additional services may be implemented. Various access points are available on the back of the unit which may or may not be used. Prior to determining the unit's final location, you need to account for the following variables:

- Optional: Where will the Ethernet cable be routed?
- What type of building material is used in this facility? Make sure you have the appropriate drills, drill bits and fasteners for routing Ethernet or power cables as they pass through walls and the like.

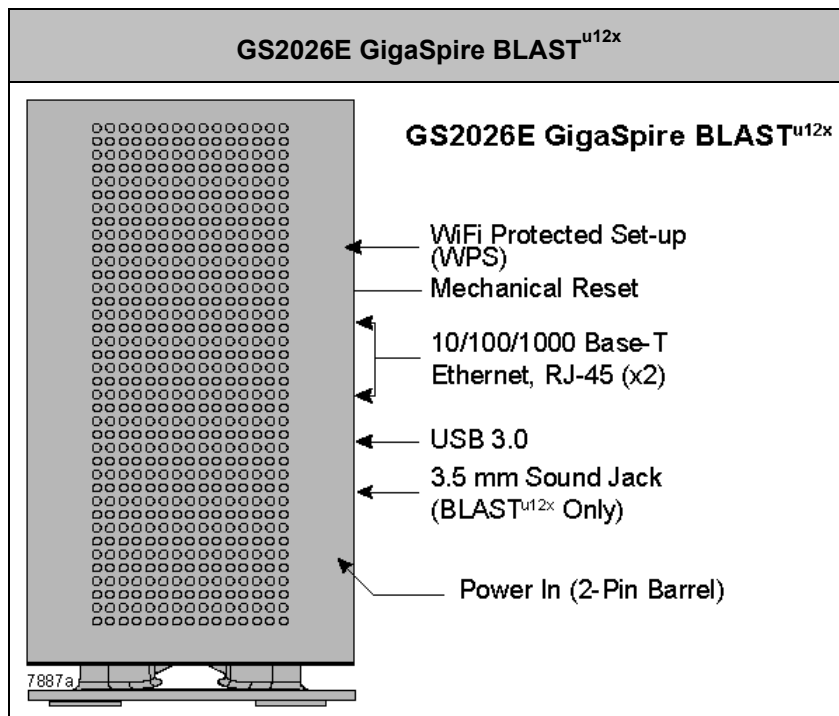

Unpacking the GigaSpire

Each GigaSpire is shipped individually in its own carton and contains the following:

- (1) GigaSpire BLAST^{u12} or BLAST^{u12X} or BLAST^{u6.1} or BLAST^{u6.2}
- (1) Power Adapter interface cord (wall wart)
- (1) Safety and Regulatory Statements Guide
- (2) Product Identification Labels with Login Credentials

After opening the carton, remove the protective packaging, ensure all components above are present, and prepare for mounting the unit.

Tabletop Mounting Dimensions

Dimensions for tabletop mounting of a GigaSpire are included here for reference.

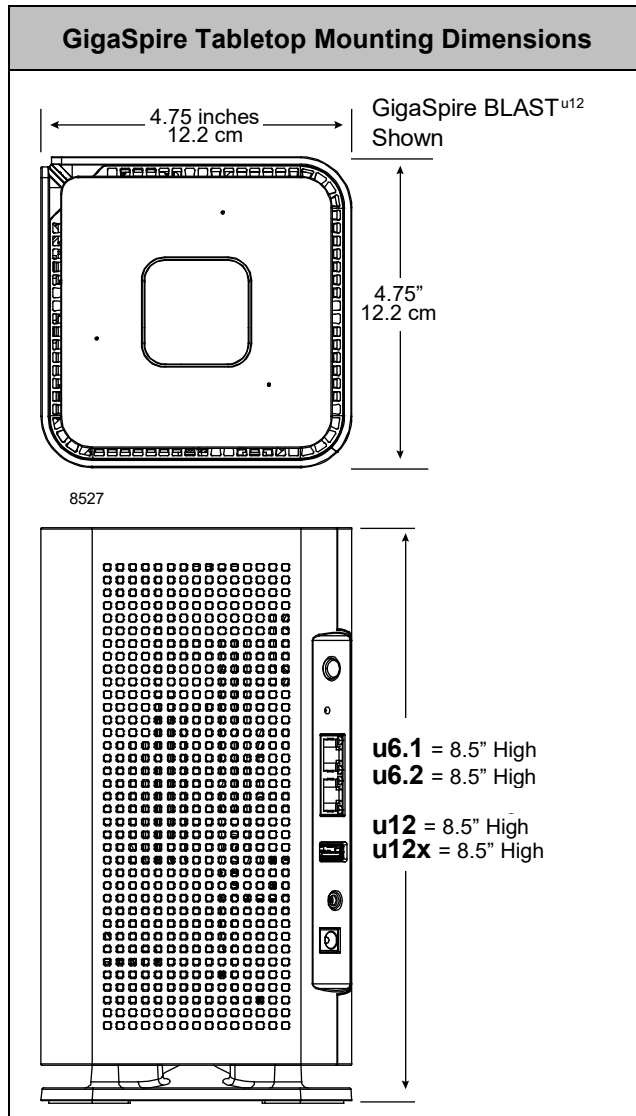

Wall Mounting Dimensions

Dimensions for wall mounting of a GigaSpire BLAST are included here for reference.

Note: The wall mount bracket is available separately and applies to u6.1, u6.2, and u6x products.

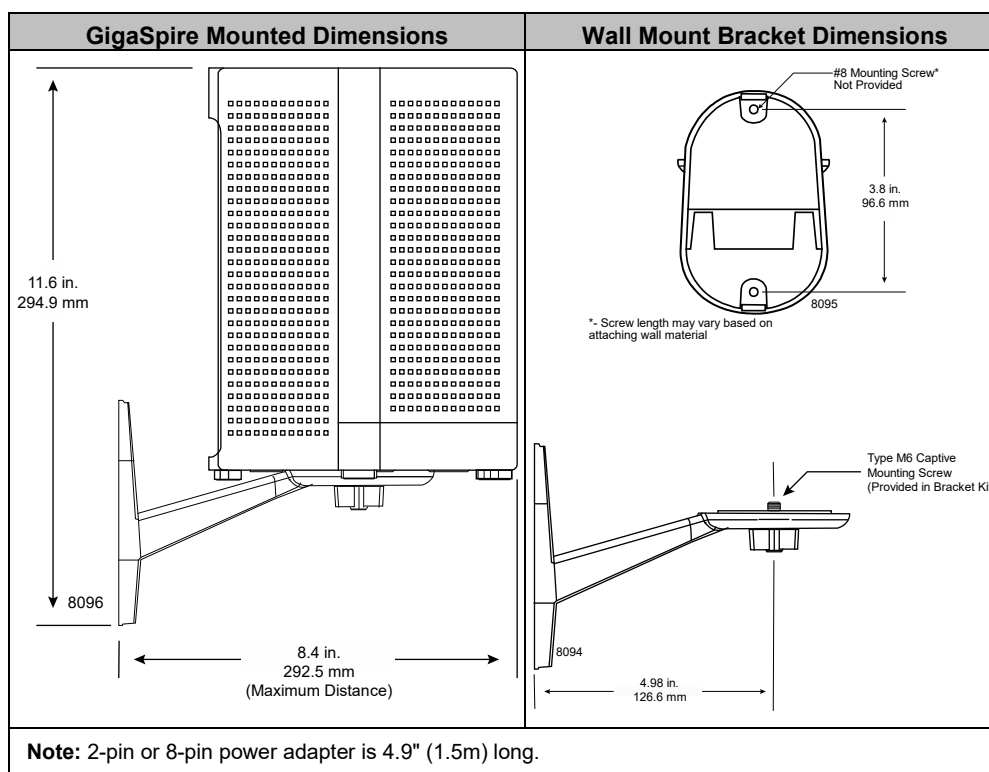

Tabletop Mounting the GigaSpire BLAST

Any Calix GigaSpire BLAST can be mounted flat on a tabletop, in a tower configuration. Four (4) rubberized feet are pre-installed on the bottom of the unit to provide a non-skid surface when placing the GigaSpire on a table or shelf.

Keep the following information in mind when considering tabletop mounting:

- Due to component placement inside the chassis, do not remove the rubber feet that are installed on the bottom of the unit. Locate the GigaSpire on the desktop in a location that is unlikely to be bumped or jostled.
- Make sure that the Ethernet cable (if used) and power supply wiring attached to the GigaSpire are secured properly and out of harms way.

Note: Once the GigaSpire is connected and turned up, Wi-Fi network parameters are persisted in memory. For this reason, if power is lost to the GigaSpire, it will be re-discovered on the network automatically, without operator intervention.

Wall Mounting the GigaSpire BLAST

The Calix GigaSpire BLAST u6 family can be wall mounted using the optional wall mount bracket. These GigaSpire BLAST models includes a 6mm captive receptacle built into the base for attaching to the captive M6 screw assembled into the wall mount bracket.

Keep the following information in mind when considering wall mounting:

- Locate the BLAST on the wall in a location that is unlikely to be bumped or jostled.
- Make sure that the Ethernet cable(s) (if used) and power supply wiring attached to the GigaSpire are secured properly and out of harms way.

Note: Once the GigaSpire is connected and turned up, Wi-Fi network parameters are persisted in memory. For this reason, if power is lost to the GigaSpire, it will be re-discovered on the network automatically, without operator intervention.

To wall mount the GigaSpire BLAST



1. Find a suitable location for attaching the wall mount bracket to the wall. Be mindful of the power source and Ethernet cable requirements then determining a mounting location.
2. Using the wall mount bracket as a template, mark the two screw locations on the wall, making sure the bracket is level.

Note: The holes of the bracket are designed to accommodate a #8 screw (not provided). Depending on the material you are attaching to, use a screw of sufficient length and strength to support the GigaSpire once attached to the bracket.

Note: If attaching to sheet rock or gypsum board, Calix recommends using a wall anchoring system to ensure the bracket is securely attached to the wall.

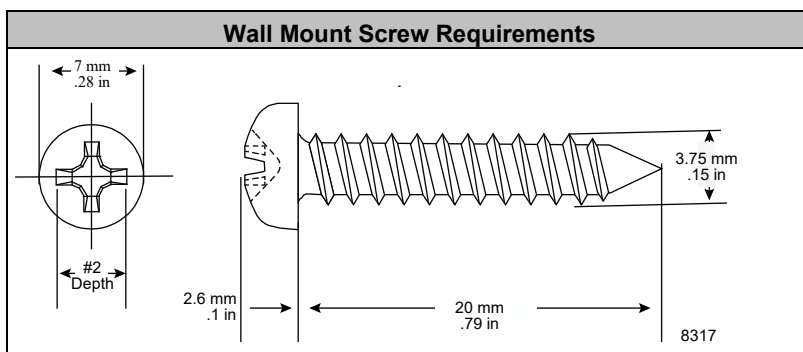

3. Drill holes in the wall and attach the bracket using two #8 screws.
4. Thread the GigaSpire on to the bracket using the captive M6 screw on the bracket.
5. Attach Ethernet cable(s) to the GigaSpire and route them to the upstream/downstream devices.
6. Attach the power supply wiring to the GigaSpire and route to the power source.
7. Secure all wiring conforming to local code.

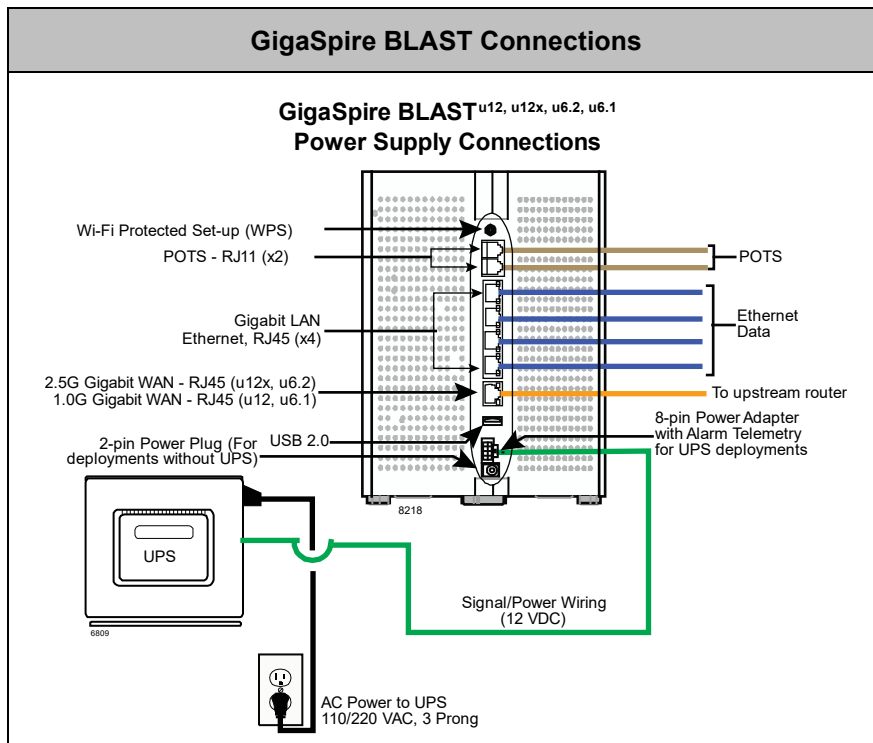

Additional Mounting Considerations

The options for mounting a GigaSpire BLAST system are many. From a best practices standpoint, keep the following in mind:

- Calix recommends mounting the BLAST nearer the ceiling for Wi-Fi performance reasons. However, this deployment scenario still mandates that an AC power outlet is located within the power cord distance of the Wi-Fi source. If installing in a greenfield environment (initial installation), plan on placing the GigaSpire within 4 feet of the power supply. As an alternative, longer power cords are available to extend the distance between the BLAST and the power supply.
- Calix also recommends keeping cabling neat and well secured wherever possible. A tidy installation allows for increased safety and an overall neater appearance. Common tools used for this purpose include cable ties and velcro straps for routing cable out of the way. Also, custom made wall plates are often used where the majority of cabling is hidden behind a wall.

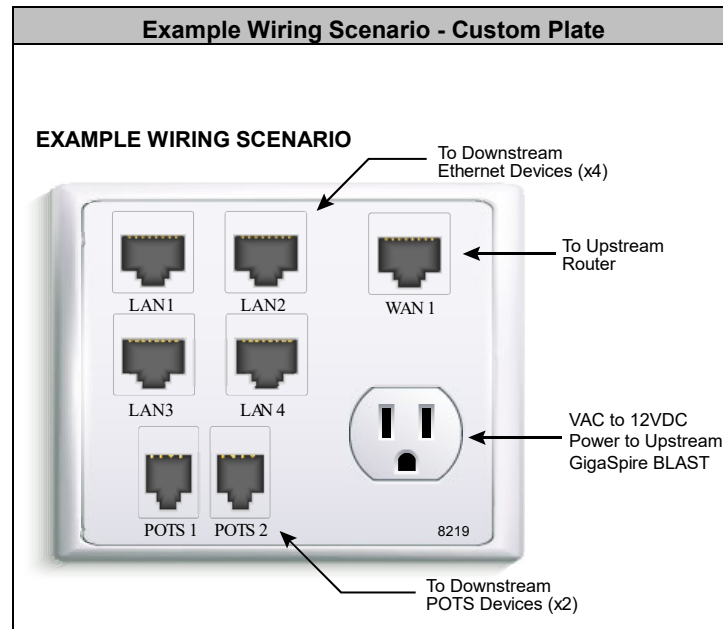

- With so many options available for deployment, your network architecture is no doubt going to be different from other subscribers. The diagram directly below is one of hundreds of options. This particular example provides the following:
 - A Local Convergence Point (LCP) for bringing fiber into the home. In this case, a Calix 803G GPON GigaPoint is located near the services panel in a climate controlled utility room or storage room that can be locked with limited access by others.
 - A customized interface panel (see above) for providing LAN, WAN, and POTS ports pre-wired near the BLAST. This allows for short cable runs and an overall cleaner deployment reducing clumsy and ill-terminated cable runs.

- A Calix GigaSpire BLAST mounted near the ceiling on the optional Wall Mount Bracket. This device provides Wi-Fi radios inside the home in a location that provides the optimal Wi-Fi signal throughout the home. The BLAST also provides a mechanical hub for deploying additional Ethernet ports or POTS ports in the home.
- In this particular deployment, a UPS is not being used and as such, only the 2-pin barrel connector is needed for powering the GigaSpire.

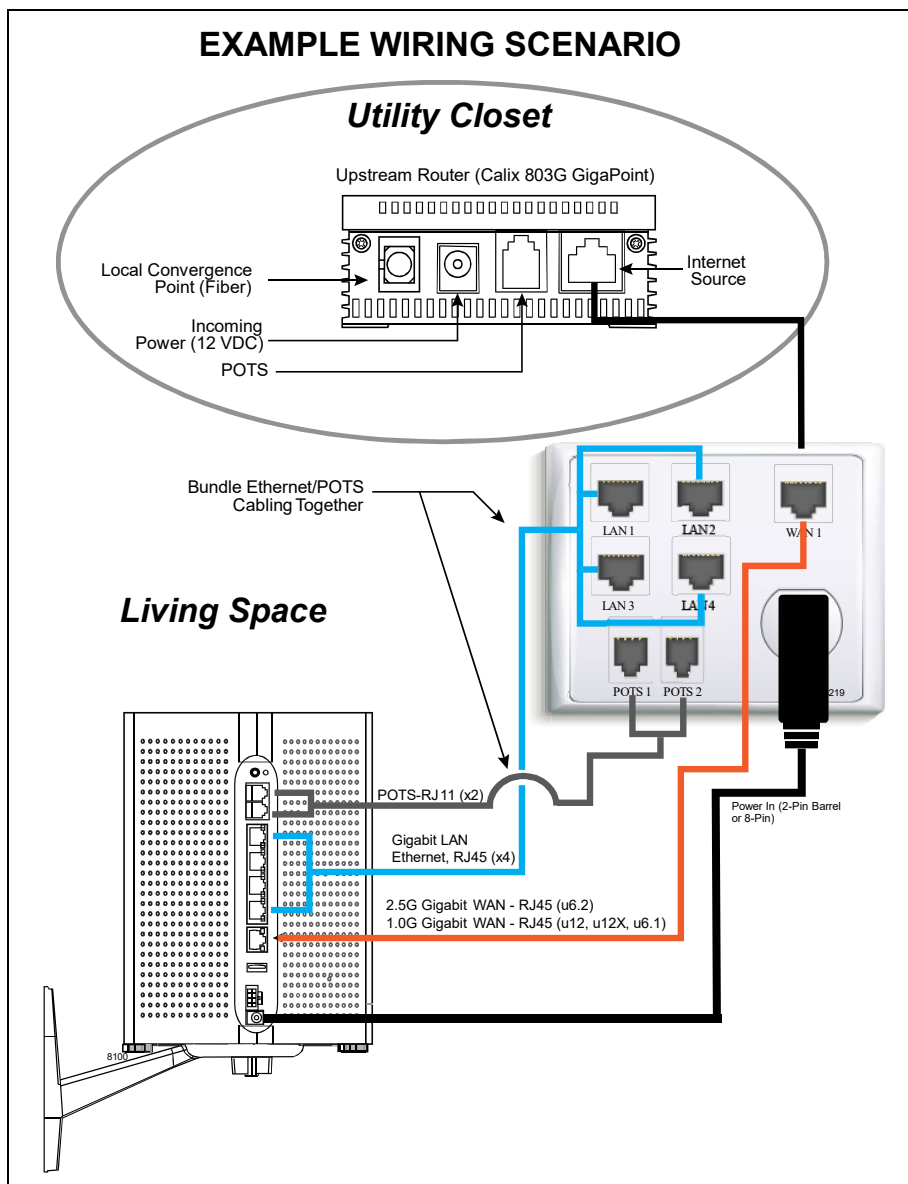



Chapter 3

Final Set-up and Testing

BLAST Reset Behavior

The reset button will do a "restore to defaults" when held for 10 seconds which clears everything except what was set by Smart Activate (restores defaults to whatever was set up during installation by the service provider).

Note: Performing a reset does not remove the default SPID and ACS URL that has been assigned to the system. This is designed intentionally, so that u6 systems cannot be taken out of service by the subscriber if they were to cancel and/or move to another service provider. The SPID and ACS URL are unique for each service provider.

Calix EDGE systems support a variety of system reset functions and provide multiple methods for invoking each of these functions, as described in this topic. Calix defines these functions and behaviors as follows:

1. Basic reset (reboot): Restarts the router.
2. Configuration reset: Resets the RG configuration settings (those visible to the subscriber/Admin user in the EWI, such as SSIDs, LAN IP scope, etc.) to defaults, but retains operator-configured management settings (those visible only to the Support user in the EWI, such as ACS URL and SPID).
3. Factory reset: Resets the router (and any attached mesh satellites) to factory default settings. A factory reset also removes devices from network management systems, including Calix Support Cloud and the Smart Home Admin Dashboard, where applicable.

These reset functions can be used as troubleshooting and/or operations tools for reset/removal scenarios, whether the device is deployed as an RG or as a subtended WAP or Satellite (GigaSpire BLAST or GigaMesh). Hardware-invoked resets behave differently depending on how long the reset button is pressed, as described below.

Function	Where Performed
Basic Reset ¹	Hardware: Press Reset button once for 1 second
	Software: EWI > Utilities > Reboot
Configuration Reset ²	Hardware: Press and hold Reset button for 15+ seconds
	Software: EWI > Utilities > Restore Defaults
Factory Reset	Hardware: no option
	Software (for support user only): EWI > Support > Tools > Smart Activate > Factory Reset
<p>Note: For operators with Calix Support Cloud (CSC), remote resets can be invoked as follows:</p> <p>¹ <i>System Tools > Reboot</i> (https://www.calix.com/content/calix/en/site-prod/library-html/software-products/cloud/nm/support/help/index.htm#88688.htm)</p> <p>² <i>System Tools > Factory Reset</i> (https://www.calix.com/content/calix/en/site-prod/library-html/software-products/cloud/nm/support/help/index.htm#88687.htm) (option actually performs just a configuration reset)</p>	

The table below provides additional notes for each Reset event:

BLAST Reset Behavior			
Reset Type	How Invoked	Expected Behavior	Notes
Basic Reset - Hardware	Press Reset button	<ul style="list-style-type: none"> Router or satellite reboots RG configuration and subscriber's custom settings persist 	Pressing the Reset button performs a standard power cycle. All configuration information persists. Device goes offline for 2-3 minutes while it completes the reboot process.
Basic Reset - Software	EWI > Utilities > Reboot	<ul style="list-style-type: none"> Router reboots RG configuration and subscriber's custom settings persist 	Subscriber (Admin user) has access to the EWI to invoke a soft reset. All configuration information persists. Device goes offline for 2-3 minutes while reboot process completes.
Configuration Reset - Hardware	Press and hold Reset button (10+ seconds)	<ul style="list-style-type: none"> Router or satellite reboots RG configuration and subscriber's custom settings reset to defaults Service provider applied management settings persist 	Reset button must be pressed and held until LEDs flash (after about 10 seconds). Device goes off-line while it completes the reboot process. RG configuration settings include all subscriber- configurable information such as login credentials for Admin user, SSIDs, LAN IP scope, etc., all of which reset to defaults.
Configuration Reset - Software	EWI > Utilities > Restore Defaults	<ul style="list-style-type: none"> Router reboots RG configuration and subscriber's custom settings reset to defaults Service provider applied management settings persist 	Subscriber (Admin user) has access to the EWI to invoke a configuration reset. Device goes offline while it completes the reboot process. RG configuration settings include all subscriber- configurable information such as login credentials for Admin user, SSIDs, LAN IP scope, etc., all of which reset to defaults.
Factory Reset - Software	EWI > Support Menu > Tools > Smart Activate > Factory Reset	<ul style="list-style-type: none"> Router reboots RG configuration settings reset to factory defaults Service provider applied management settings reset to factory defaults 	Function available only to operators via EWI Support user (not available to subscriber/Admin user). Service provider management settings include all information visible on the EWI Support tab, such as login credentials for Support user, TR-69 ACS URL and login credentials, SPID, etc., all of which reset to defaults.

Powering the GigaSpire BLAST - No UPS

The information below describes the powering of any GigaSpire BLAST that **does not** include a UPS.

To power up the GigaSpire

1. Locate the 12 VDC Power Adapter.
2. Attach one end (2-pin barrel connector) to the rear of the GigaSpire.
3. Plug the other end into any available 110/220 VAC wall outlet.
4. The GigaSpire begins its start-up sequence.

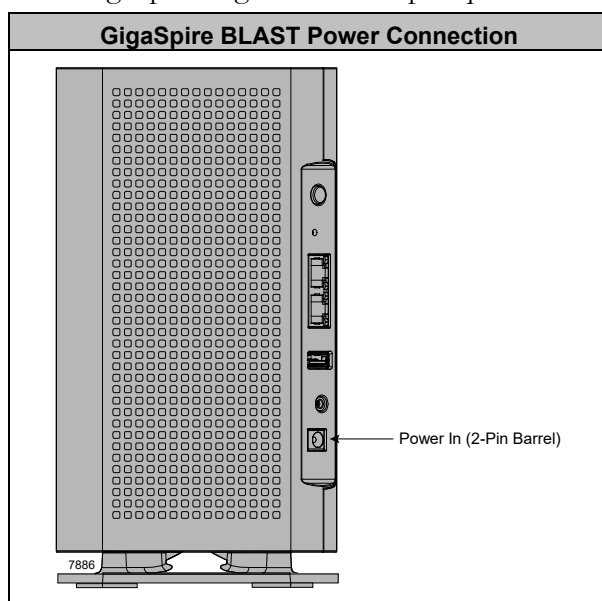

(Optional) Mounting the UPS

Prior to putting the GigaSpire into service, the UPS must be mounted to ensure the low voltage power cord that is connected between the UPS and the GigaSpire is long enough to span the distance between the two devices.

Depending on your configuration, power cords of varying lengths may be included:

- The AC power cord that runs from the UPS to the AC wall outlet is 8-feet long. Make sure an AC outlet is available within that distance.
- The power/signal cord that runs from the UPS to the GigaSpire is available in any of the following configurations based on model.

Any GigaSpire BLAST incorporating a UPS (Sold Separately)

- Connectorized Power and Signal Cable - An 8-pin (GigaCenter end) to 8-pin terminal block (UPS end) cable available in 3 foot (1 meter) or 10 foot (3 meters) lengths.
- Connectorized Power and Signal Cable - An 8-pin (GigaCenter end) to dressed and tinned (un-terminated) cable available in 20 foot (6 meter) length.

Mounting the UPS



WARNING! High voltage electrical and pressurized natural gas lines may be present. Make sure you fully understand the locations of these and all other utility connections before drilling through any surface.



CAUTION! The UPS is designed for indoor installation and must be installed in a location with adequate airflow.

Make sure the UPS is not installed under water pipes which may leak or drip from condensation.

Reference: The UPS must be located less than 50 feet (15.2 meters) from the GigaSpire when using an 18 AWG Type I power cord or less than 70 feet (21.3 meters) from the GigaSpire when using 16 AWG Type II power cord.

1. Unpack the UPS and associated hardware from the carton.
2. Find a suitable location for the UPS and prepare mounting screws per the mounting hole pattern shown below.

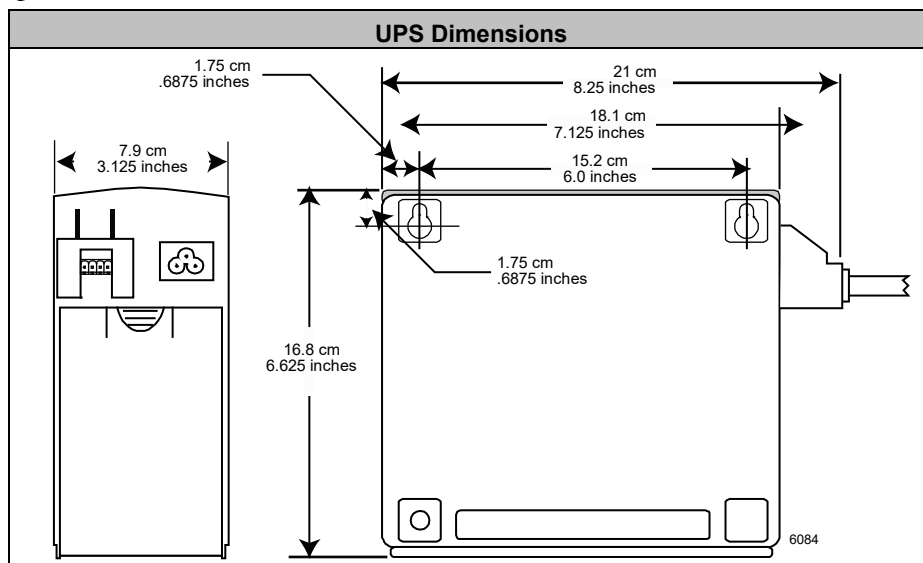

3. Pre-drill mounting holes (to accept an 8-32 pan head screw - not provided) of the appropriate size.

Important: Make sure the material you are mounting the UPS to is of sufficient strength to support its weight of 7.16 pounds (3.25 kgs).

4. Insert a screw into each hole, leaving 3/16-inch (.48 cm) of the screw protruding from the wall.
5. Align the key slots on the top of the UPS with the screws and slide the unit down into place.
6. If the UPS is not snug after test fitting the mounting screws, remove the UPS and tighten the mounting screws slightly to allow for a tighter fit.

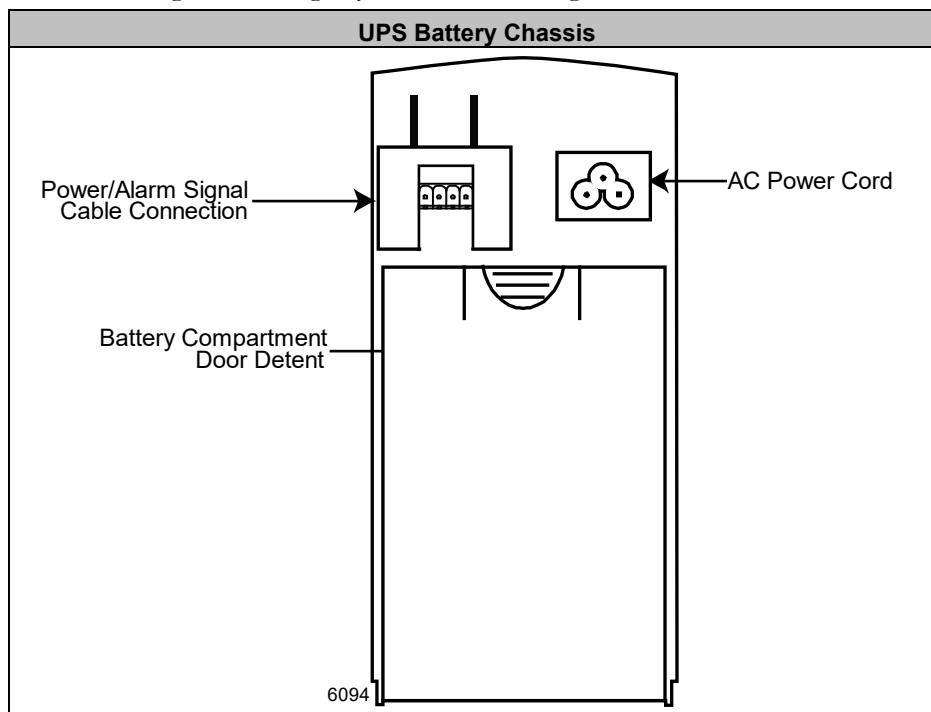

7. Unpack the battery and slide it into the UPS housing.
8. Attach the battery leads to the battery (red to red, black to black).
9. Re-install the battery cover.

Connecting to the Internet

The method by which the GigaSpire is deployed will impact the internet connection. With power applied to the GigaSpire BLAST, perform the following steps based on the role the GigaSpire plays in the network.

Connecting to a residential gateway

If the GigaSpire is configured as a Residential Gateway, connect an Ethernet Cable to its WAN port from the WAN modem (ONU, cable modem, or DSL modem).

Connecting as a Mesh point







If the GigaSpire is configured as a MESH point, connect an Ethernet cable from its WAN port to another GigaSpire or wirelessly connect the two devices.

Additional Comments

- Once your GigaSpires LED turns BLUE, you are connected to the upstream WAN modem.
- At start-up, GigaSpire Wi-Fi radios are defaulted to on.
- To configure your GigaSpire, connect an Ethernet cable between your PC and the LAN port of your GigaSpire and enter the default IP Address of the device (192.168.1.1) into your browser.
- Wi-Fi radios can be configured using the default settings:
 - SSID: Printed on the product label in the gift box. (CXNKxxxxxxxx)
 - Number of radios: 2 (2.4 GHz and 5 GHz)
 - Wi-Fi Protocol supported: 802.11a/b/n/g/ac/ax
 - Credentials: Login and password printed on the product label in the gift box.

LED States - GigaSpire Turn-up

The LED's located on the corner of the unit provide information on the status and current state of the device. Below, you will find a detailed status of the power-up cycle.

Unit Status		
Power-up Status	Function	LED Status
Off	Power is off. <ul style="list-style-type: none"> The unit has not been turned on or There is no power to the unit or The UPS battery has been discharged and there is insufficient power to continue operation. Note: LED is off.	
Booting Up, Software Upgrade in Process	Unit is in the boot-up process or service/software is being upgraded. Flashes orange every second assuming software has taken over. Note: LED is on.	
Boot-up Failure	Boot-up failed (assuming software has taken over) Note: Cycles at 8/10 of a second Note: LED is on.	
Connected to Internet	Unit has successfully booted up, local services are up, and connected to the Internet. Note: LED is on.	
Service Failure, No Internet	No service, no Internet. Note: LED is on. Notes: Cycles at 1.6 seconds	
Alexa has been triggered, Alexa is listening	Alexa is listening and active. Listing once the trigger word is heard. Note: LED is on. Note: Cyan on continuously.	

LED States - WPS Functionality

Pressing the WPS button a single time is primary mode, for mobile device connecting to the RG. Pressing WPS button for about 3 seconds is backhaul mode, for satellites connecting to the RG. Pressing WPS button 3 times in 10s is IPTV mode, for IPTV connecting to the RG.

After pressing the button, the WPS feature will stay in pairing mode for 120 seconds.





During this time, other Wi-Fi capable devices can be paired to the Gateways Wi-Fi radios (5 GHz band) by initializing a similar WPS function on the other device or mesh satellite thereby creating an association with the Gateway SSID and the mesh satellite. When the Gateway and the mesh satellite are successfully paired, they will have the same primary SSID (2.4 and 5 GHz).

Sequence of WPS operation



1. Press WPS button a single time (3+ seconds in a 10-second window, according to SW convention).
2. Device Gateway enters pairing mode (up to 120 seconds).
3. If another device is found, the device pairs with the device.
4. If no device is found, the unit will exit pairing mode after 120 second.

Note: WPS LED behavior takes priority even if Alexa is in use during the pairing period.

Note: The WPS behavior of the GigaMesh is identical to other GigaSpires.





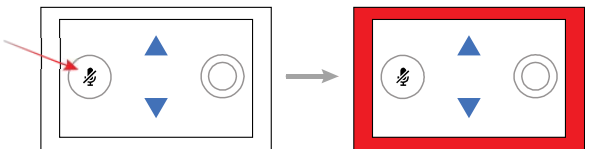

WPS Status			
Power-up Status	Function	LED Appearance	LED Status
Device booting up	<p>Unit is in the process of booting up or service/software is currently being upgraded.</p> <p>LEDs flash every second assuming software can control the LEDs.</p> <p>Note: If the device is connected via WIRED or WIRELESS backhaul, ignore pairing and signal strength behavior.</p>	Alternating on/off at 1000 m/sec per cycle	
Boot-up Failure	Unit boot-up failed (assume failure occurs after software has taken control of the LEDs)	Alternating on/off at 800 m/sec per cycle	
WPS Pressed, Pairing Attempt Started	<p>WPS is enabled upon pressing the WPS a single time. The device will stay in pairing mode for 120 seconds.</p> <p>During this time, other Wi-Fi capable devices can be paired to the Gateway Wi-Fi radios (5.0 GHz band) by initializing a similar WPS function on the other unit or mesh satellite thereby creating an association with the Gateway SSID and the mesh satellite. When the Gateway and the mesh satellite are successfully paired, they will have the same primary SSID (2.4 and 5.0 GHz).</p> <p>WPS LED behavior takes priority even if Alexa is used during the pairing period.</p>	LED bar begins flashing at 500 m/sec intervals and continues for at most 120 seconds.	
Gateway Not Found	If no device is found after the initial 120 second time-out, the WPS/Strength LED bar shifts from the blinking green to solid red.	LED bar remains red for another 60 seconds, then reverts to the "No Internet failure status.	

LED States - Miscellaneous Controls

Additional LED States		
Alexa Status	Function	LED Status
Alexa System/Configuration Change	<p>Alexa status is changed (perhaps a changing of the Wake word from within the Alexa App).</p> <p>Note: All four LED's on.</p> <p>Note: Toggles off and on every 1.26 seconds until update is complete. Returns to GigaSpire behavior when done.</p>	
Alexa System Alarm	<p>Alexa is not functional. Alarm status is triggered after:</p> <ul style="list-style-type: none"> The Wake word is uttered and there is no response from Alexa Cloud The local Internet connection has been lost. <p>Note: All four LED's on.</p> <p>Note: Toggles three times only at .62 seconds before returning to GigaSpire LED status.</p>	
Mute Microphone	<p>Applies to the square LED on the top of the 2026E GigaSpire.</p> <p>Default position is microphone on. (LED Off)</p> <p>Pressing the Mute microphone icon causes the LED to illuminate solid red.</p> <p>Note: The functionality of the top LED is hardware controlled.</p>	See Below
		

LED States - Alexa

Alexa behaviors are detailed below.

Alexa LED States		
Power-up Status	Function	LED Status
Alexa has been triggered, Alexa is listening	Alexa is listening and active. Listing once the trigger word is heard. Note: All four LED's on. Note: Cyan on continuously.	
Alexa Thinking	Alexa is thinking waiting for a response from AVS. Note: All four LED's on. Note: Toggles from Cyan to Blue every .62 seconds	
Alexa Responding	Response received from AVS and voices the response. Note: All four LED's on. Note: Toggles from Cyan to Blue every 1.26 seconds.	
Ongoing Alexa Activities	On-going Alexa actives such as playing music, reading news, reading e-books. Note: All four LED's affected Note: GigaSpire LED status's return once Alexa activities are complete.	
Alexa Notifications	Alexa notifications have arrived. One .62 second burst followed by an off cycle (same duration) for each received notification. Note: All four LED's affected Note: Toggles for .62 seconds between yellow and off.	
Alexa Notifications Queued	Alexa Notifications have arrived but have not be requested by the user. Continuous slow pulse until notifications are picked up. This state continues unless a temporary interruption by a regular Alexa listen/think/respond interaction is requested. Returns to GigaSpire LED status once all notifications have been picked up. Note: All four LED's affected Note: Toggles for 1.26 seconds between yellow and off.	
Alexa Do Not Disturb	Alexa DND has been provisioned (Enable DND, Disable DND) Note: All four LED's affected Note: Toggles for 1.26 seconds	

LED States - u6.1, u6.2

The LED's located on the corner of the device provides information on the status and current state of the device. Below, you will find a detailed status of the power-up cycle.

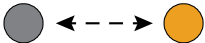
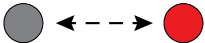
Power Off and Boot-up		
Description	Colors	Indication
OFF <ul style="list-style-type: none"> Power is Off The unit has not been turned on <i>or</i> <ul style="list-style-type: none"> There is no power to the unit <i>or</i> <ul style="list-style-type: none"> Any auxiliary battery has been discharged and can no longer power the unit. 	Off	
Boot-up, SW Upgrade in Process <ul style="list-style-type: none"> Unit is in the process of booting up or services/software is being upgraded Flashing ever 1 second assuming software can control the LED 	Off & Orange Cycles @ 1000 msec	
<ul style="list-style-type: none"> Boot-up Failure Unit boot-up has failed (assuming software can control the LED). 	Off & Red Cycles @ 800 msec	

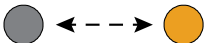
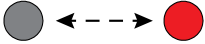
Unit Status		
Power-up Status	Function	LED Status
Off	Power is off. The unit has not been turned on <i>or</i> There is no power to the unit <i>or</i> The UPS battery has been discharged and there is insufficient power to continue operation. Note: The LED is off.	
Boot-up or SW Upgrade in Process <ul style="list-style-type: none"> Unit is in the process of being boot up or service/software is being upgraded Flashing every 1 second on cyan color - assuming SW can control the LEDs. 	Off and Orange (1000 msec) Note: The LED is on.	
Boot-up Failure <ul style="list-style-type: none"> Unit boot-up failed (if SW can control the LEDs) 	Off and Red (800 msec) Note: The LED is on.	

GigaMesh LED Behavior

WPS is enabled upon pressing the WPS button a single time. After pressing the button, the GS202xE will stay in pairing mode for 120 seconds.

During this time, other Wi-Fi capable devices can be paired to the GS202xE Gateway Wi-Fi radios (5 GHz band) by initializing a similar WPS function on the other GS202xE or GM1020 mesh satellite thereby creating an association with the Gateway SSID and the mesh satellite. When the Gateway and the mesh satellite are successfully paired, they will have the same primary SSID (2.4 and 5 GHz).

